



PFM SCREEN

Specialize In Wire Conveyor Belt Manufacturing And Solution.



Honeycomb Conveyor Belts

www.industrialconveyorbelt.com



PFM SCREEN

Specialize In Wire Conveyor Belt Manufacturing And Solution.

Overview

PFM Screen began manufacturing Honeycomb Conveyor Belt in 1987, and they are still among the most versatile and most economical straight-running belts available.

Honeycomb conveyor belt, also called flat wire conveyor belt. The honeycomb belt is constructed of cross rods and a flat metal strip. At the sides of the belt the cross rods have a welded ring (welded edges). In some dimensions, it is possible to give the sides of the belt a clinged edge. There are several predefined belt executions with different pitches and material dimensions. The belt can also be provided with side plates or flights. The flat wires are arranged in the form of lattice and jointed with the straight round rods. The material of flat wire belt are commonly high carbon steel, galvanized steel, stainless steel and other materials.

Honeycomb conveyor belt is a perfect product with both durability and suitable open area. It is temperature resistance, which is popular in the baking conveying applications. The flat surface of honeycomb conveyor belt supplies stable conveying during using. Honeycomb belts are used in production processes with temperatures of -30°C up to $+400^{\circ}\text{C}$ in food and other industries.

Honeycomb conveyor belt advantages:

- Belt edge has no catch points, no welds
- Twice the life of competitive belts
- Installation requires no special tools
- Positive driven for excellent belt tracking
- Up to 81% open area for excellent flow through
- Allows for tight transfers
- Available up to 150 inches wide
- High strength-to-weight ratio
- Welded button edge or clinched edge
- Flat carrying surface
- Easy to clean and to install

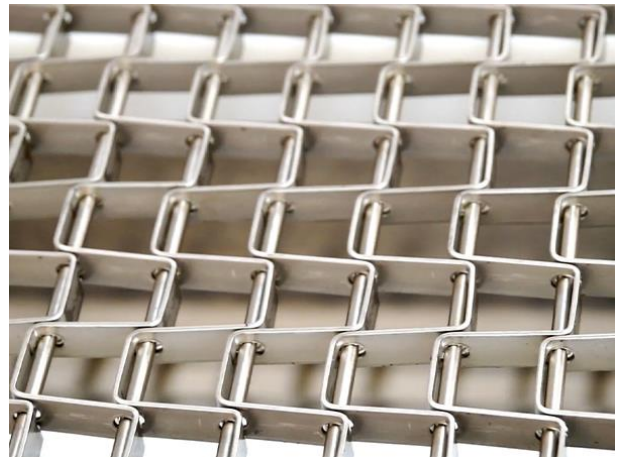
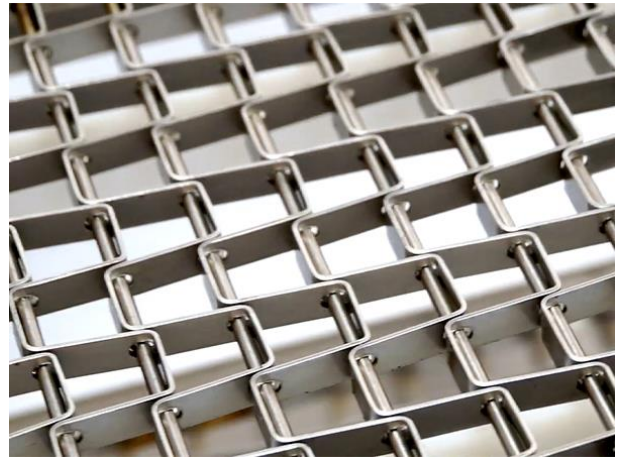

Specialize In Wire Conveyor Belt Manufacturing And Solution.

- Easily joined
- Strong edge reduces snagging or catching on conveyor protrusions



Edge Availability

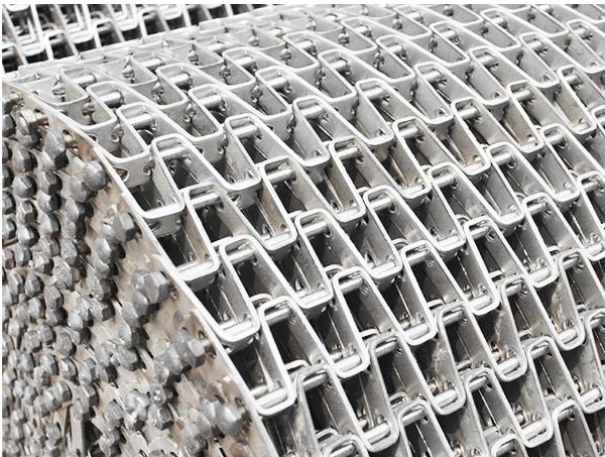

Honeycomb belt with welded edges

Honeycomb belt with clinched edges



Specialize In Wire Conveyor Belt Manufacturing And Solution.



Honeycomb belt with Chain edges

Material Availability

The Honeycomb belts is standard made of mild steel, galvanized mild steel, stainless steel AISI 304 and AISI 316. The belt needs minimal maintenance and will have a working life of many years if used well.

Specifications

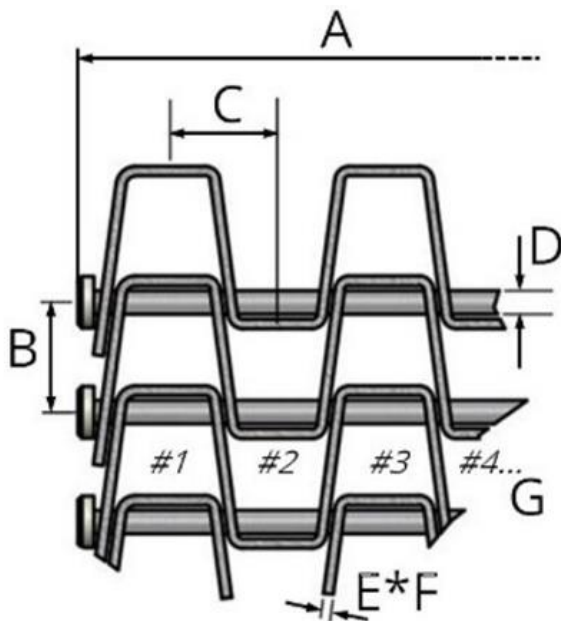

- A: Overall Width (mm)
- B: Cross Rod Pitch (mm)
- C: Nominal Lateral Pitch (mm)
- D: Cross Rod Diameter (mm)
- E: Height of flat strip material (mm)
- F: Thickness of flat strip material (mm)
- G: Number of Apertures Across Width (mm)

Specialize In Wire Conveyor Belt Manufacturing And Solution.

Specifications of Honeycomb conveyor belts				
Item No.	Cross Rod Pitch (mm)	Nominal Lateral Pitch (mm)	Flat Strip (mm)	Cross Rod (mm)
H CB01	13.7	14.6	10x1	3
H CB02	26.2	15.55	12x1.2	4
H CB03	27.4	15.7	9.5x1.25	3
H CB04	27.4	24.7	9.5x1.25	3
H CB05	28.6	15	9.5x1.25	3
H CB06	28.6	26.25	9.5x1.25	3
H CB07	28.4	22.5	15x1.2	4

NOTE: Custom specification is available if you can't find the suitable size.

Applications

The Honeycomb conveyor belts, with high temperature resistance, large open area, flat surface is widely used in the following applications.

- Transport systems
- Heating systems
- Baking systems
- cooling systems
- washing systems
- Freezing systems
- Packaging systems
- sorting systems
- drying systems
- product handling systems
- sieving systems
- bread production systems
- waste handling systems



Honeycomb conveyor belt for Heating



PFM SCREEN

Specialize In Wire Conveyor Belt Manufacturing And Solution.



Honeycomb conveyor belt for Packaging



Honeycomb conveyor belt for Freezing

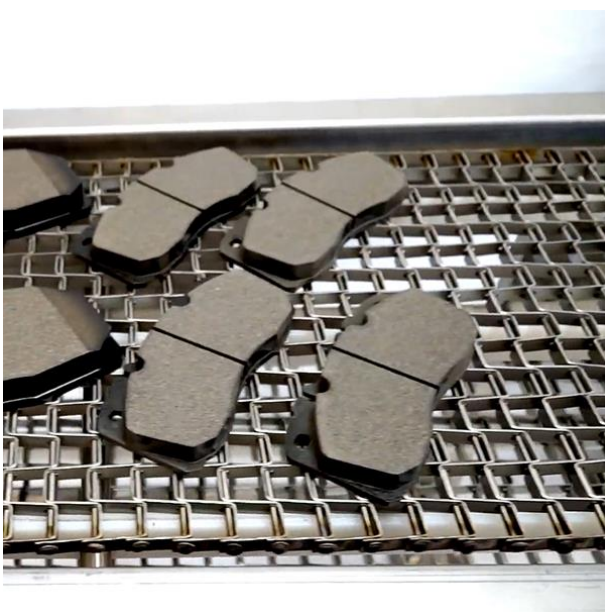

Honeycomb conveyor belt for product handling



Honeycomb conveyor belt for bread production



PFM SCREEN

Specialize In Wire Conveyor Belt Manufacturing And Solution.



Honeycomb conveyor belt for Canning

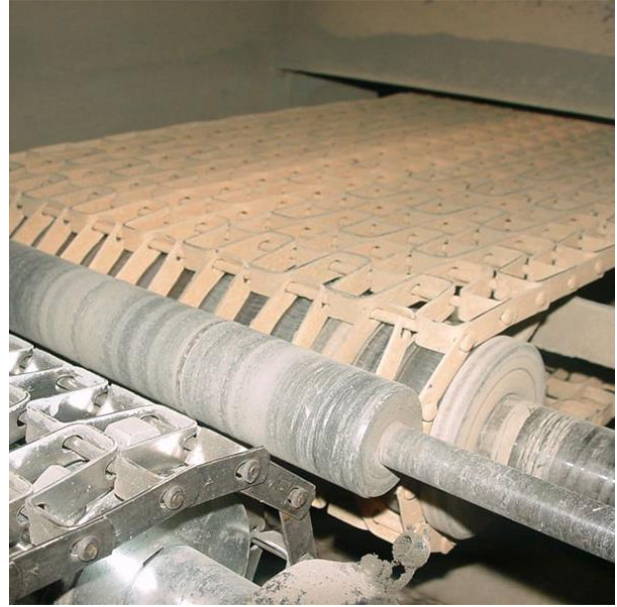

Honeycomb conveyor belt for Sieving



PFM SCREEN

Specialize In Wire Conveyor Belt Manufacturing And Solution.

METAL CONVEYOR BELTS



Balanced Woven Conveyor Belts



Compound Weave Conveyor Belts



Chain Link Conveyor Belts



Flexible Rod Conveyor Belts



Flat Flex Conveyor Belts



Eye Link Conveyor Belts

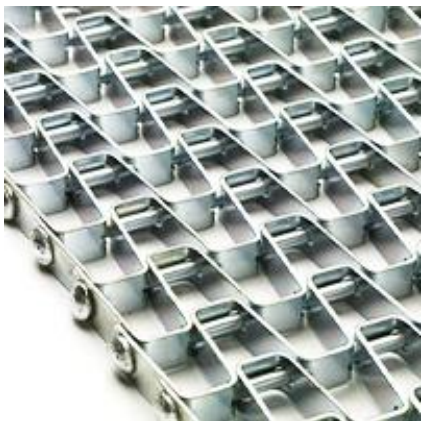

Honeycomb Conveyor Belts



Plate Link Conveyor Belts

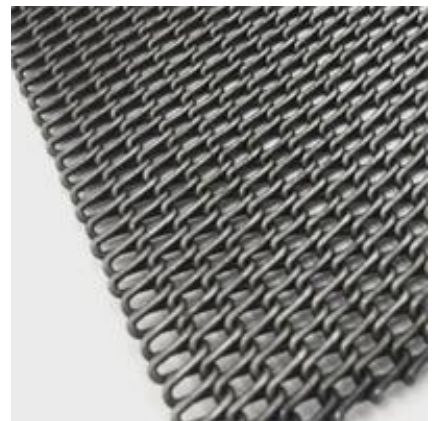

Biscuit Baking Belts



PFM SCREEN

Specialize In Wire Conveyor Belt Manufacturing And Solution.



Ladder Conveyor Belts

CONVEYOR BELT ACCESSORY



Sprockets



Chain links

Our policy is one of continuous improvement and we reserve the right to change specifications at any time and without notice or modify these to suit manufacturing processes

Add: No.1107, Floor 11, Dazhong Plaza, Yinhe Road, Guangyang District, Langfang, Hebei, China 065000

Factory Add: Industrial Park Zone of South Anping County, Hebei Province, China 053600

Tel: +86-2188808

Mobile: +86-15369679157

E-mail: info@pfmscreen.com

Website: www.industrialconveyorbelt.com

www.industrialconveyorbelt.com